

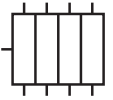

**Progressive distributor
VPA-I**



Connecting plate and proportioning block of sea-water resistant bronze

Use:

In progressive mode based central lubrication systems.

The main features of **WOERNER** progressive distributors are as follows:

- **Accurate proportioning volumes.**
- Clear and precise arrangement of control channels in **spite of small-size construction.**
- **Modular system construction.**
Quick fault remedy possible without having to loosen the pipeline.
- **9 different proportioning volumes** selectable in accordance with the lubricant required.
- **Extremely long service life** due to refined sliding surfaces.
- **Pluggable monitoring elements** can be replaced during operation.
- **No proportioning decrease at the piston monitored.**

Technical data:

Proportioning volume per cycle: 0,1 ... 0,9 cm³
 Operating pressure at max.: 150 bar
 Throughput volume:
 Oil at max.: 2500 cm³/min
 Grease at max.: 250 cm³/min
 Delivery medium:
 Oil-viscosity: >6 cP
 Grease up to: NLGI-category 2
 Material:
 Proportioning block and connecting plate: sea-water resistant bronze
 Internal parts: Steel
 Temperature range: -20 ... +80 °C

Mounting position: usually as needed

Note: In case of heavy vibration or shock load, install the distributor such that piston axes are situated vertically to the main direction of shock impact.

An optimum ventilation of the whole lubrication system is the precondition for its functionally safe operation.

For quicker ventilation, the flow direction from bottom to top in the distributor is of advantage (inlet on bottom side).

The distributor must not be "distorted". Therefore, when mounting it, always be careful that the supporting surface is level.

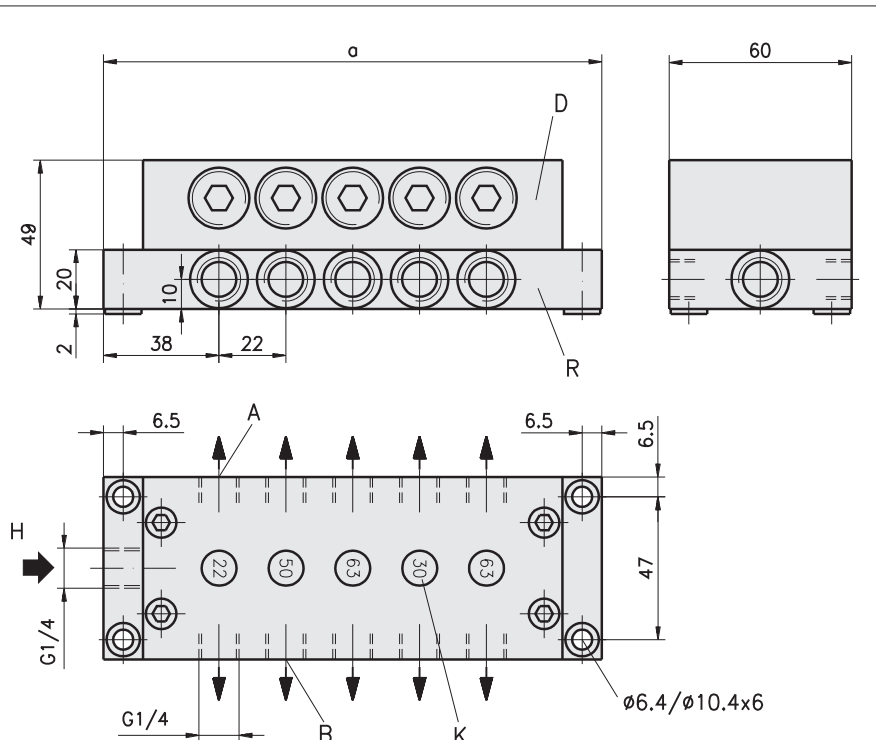

- A = Mounting point at distributor (for viewing indicator and electrical functionality check)
- B = Mounting point for viewing indicator at distributor (if point A is occupied)
- D = Proportioning block DPA-I
- H = Main line
- K = Proportioning volume distinctive number
- R = Connecting plate APA-I

Number of outlets	Length "a"
6	120
8	142
10	164

- Subject to modifications -

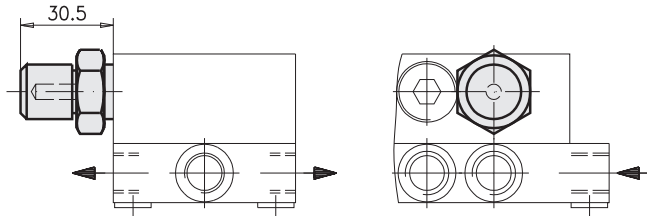
Visual check

Functional checks:
Visual check:

In a translucent polyamide casing, a red pin being fixed to the piston shows the piston's movement.

Casing material: Polyamide, translucent
 Ambient temperature: -10 ... +80 °C
 Weight: 0,35 kg
 Mounting point at distributor: A or B

Electrical check with initiator:
Casing for initiator:

A pin being connected with the piston attenuates an initiator once per cycle.

Version "D":

Casing material: Polyamide, translucent
 (Piston movement is visible)
 for initiators with a
 switching distance of: ≥ 8 mm

Version "W":

Casing material: Polyamide, black
 for initiators with a
 switching distance of: ≥ 5 mm

Use initiator with M18x1 thread!

(When using other initiators than those depicted below, such initiators must be checked for suitability.)

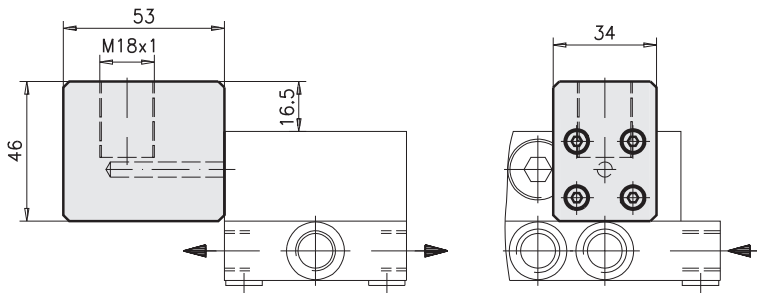
Casing for initiator

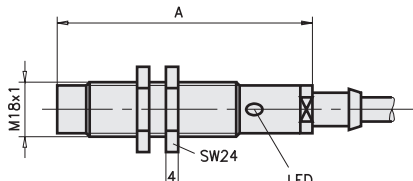
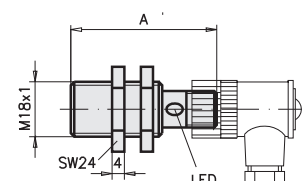
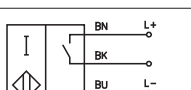
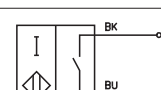
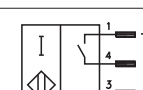
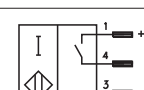
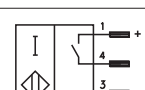
Choice of initiators:

Designation / Purchase-no.	Initiator "C" 913.900-03	Initiator "F" 913.900-11	Initiator "N" 913.900-21	Initiator "I" 913.900-14	Initiator "2" 979.044-88
Suits for	Casing "W" Switching dist. ≥ 5 mm	Casing "D" and "W" Switching dist. ≥ 8 mm	Casing "D" and "W" Switching dist. ≥ 8 mm	Casing "W" Switching dist. ≥ 5 mm	Casing "W" Switching dist. ≥ 5 mm
Dimension drawing:					
Connection diagram:					
Operating voltage:	10 ... 30 VDC	20 ... 250 VUC	10 ... 30 VDC	10 ... 30 VDC	10 ... 30 VDC
Residual ripple:	$\leq 10\%$		$\leq 15\%$	$\leq 15\%$	$\leq 15\%$
Load current at max.:	250 mA	500 mA	130 mA	200 mA	130 mA
Protection system:	IP67	IP67	IP67	IP67	IP67
Power connection:	Cable 3 m	Cable 3 m	Unit plug (see accessories, page 3)		
Length "A":	60 mm	62 mm	45 mm	100 mm	65 mm

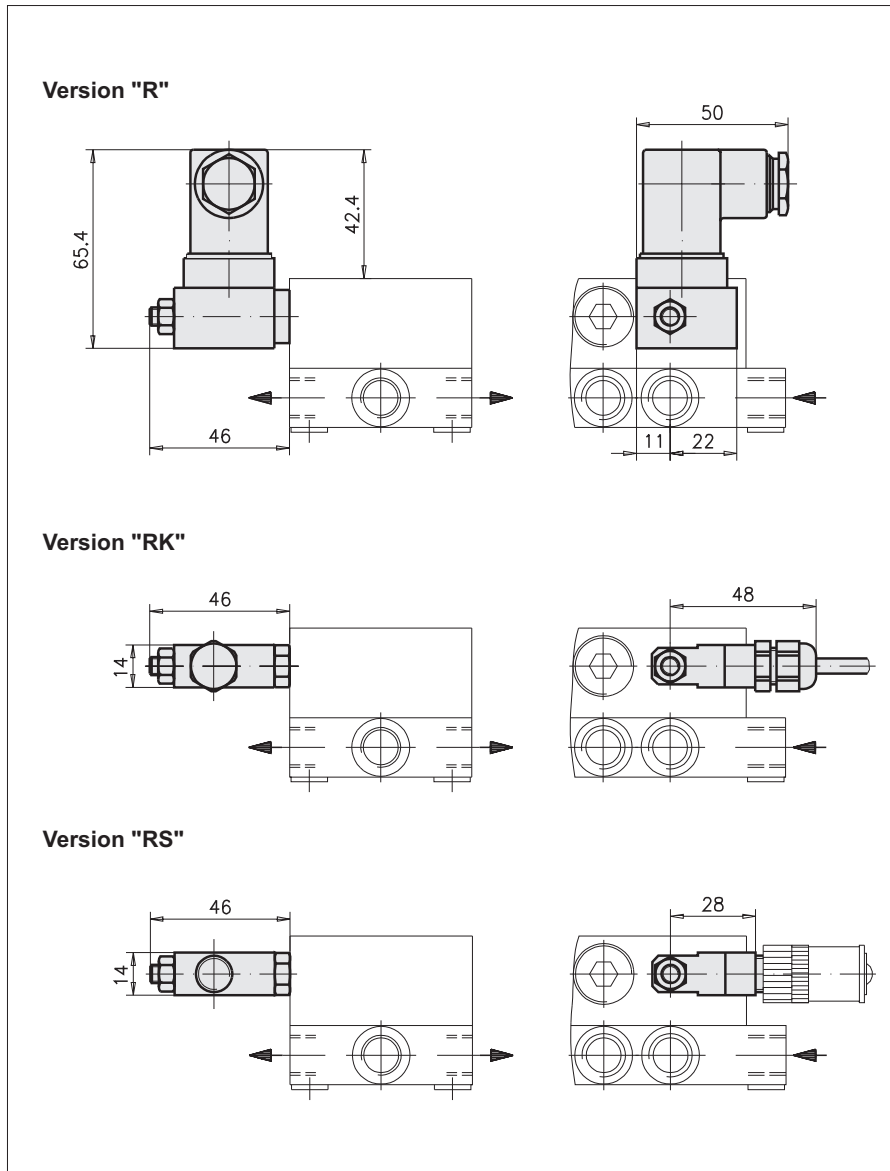

- Subject to modifications -



Electrical check with reed contact:

A magnet connected with the piston switches the reed contact once per cycle.

Switching voltage: 10 ... 36 VUC
 Switching current at max.: 25 mA
 Switching power at max.: 0,9 VA
 Ambient temperature: -5 ... +80 °C
 Mounting point at distributor: A

Version "R" with plug-in connection DIN 43650A:

Material (casing): sea-water resistant bronze or 1.4305
 System of protection: IP65



Version "RK" with cable:

Material (casing): PA or 1.4305
 System of protection: IP65
 Cable
 Length: 10 m
 Cross section: 2x0,75 mm²
 Material: Oelflex

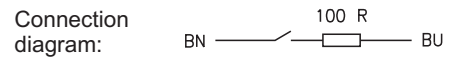

Version "RS" with unit plug 4 pin (M12): (for matching cable jack see accessories)

Material (casing): PA or 1.4305



Accessories:

Cable jack for functionality check "RS" and initiator (state purchase-no., please)

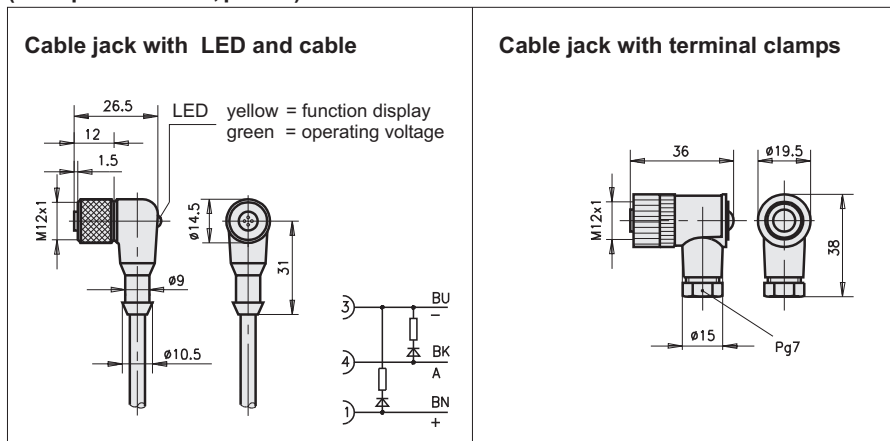

















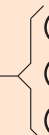





Cable jack with LED and cable:

Purchase-no.: 913.404-19
 Operating voltage: 10 ... 30 VDC
 Cable
 Cross section: 3x0,34 mm²
 Length: 5 m
 System of protection: IP68

Cable jack with terminal clamps: (without LED)

Purchase-no.: 913.404-24
 Connection type: Screws
 Connection cross section: at max. 0,75 mm²
 Cable diameter: 4 ... 6 mm
 System of protection: IP67

Purchase-designation: Progressive distributor 

Number of outlets	Functionality check			Proportioning volume per piston stroke and outlet [cm ³] distinctive no. 	Gasket material	
	Visual check	electrical check	Initiator			
6 ... 10 increasing by 2 outlets each	without 	without 	without 	0,10  0,50 	NBR (Perbunan) 	
		Reed contact 		0,15  0,63 		
	with 	translucent initiator casing switching distance ≥8mm 	 	0,22  0,75 		FPM (Viton) 
		reinforced initiator casing switching distance ≥5mm 	    	0,40 		

Purchase-designation: Proportioning block 

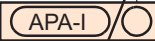
Purchase-designation: Connecting plate 

Note:
 When a functionality checking device is to be added on, the proportioning volume must be 0,22 cm³ at least at the last point!

Purchase-example:

Progressive distributor with 10 outlets, without visual check "0", with casing for initiator "W" and initiator "C", proportioning distinctive numbers "50", "63", "30", "30", "63", gasket material "P".

Purchase-designation:

VPA-I / 10 / 0 / W / C / 50 / 63 / 30 / 30 / 63 / P

Combination of outlets, doubling the proportioning volume at an outlet:

Connect opposing outlets by removing the "Z" screw.
 Close the not needed outlet with the lock screw.
 Without removal of the "Z" screw, no outlet must be locked.

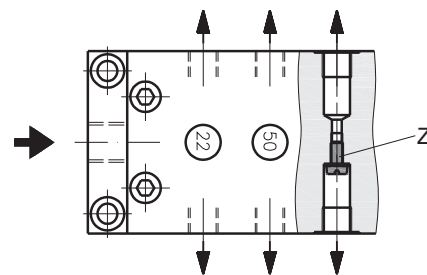

- Subject to modifications -



Functional process fig. 1 ... 4:

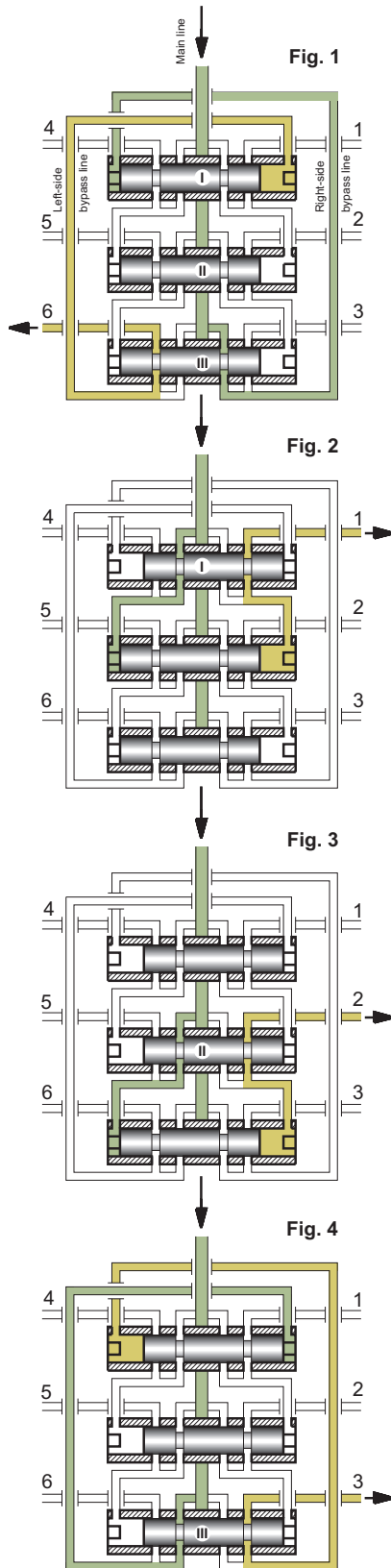

The lubricant flows from the main line through the right-side ring groove of piston III as well as the bypass line (right) and to the left side of piston I and moves it into its home position. The lubricant displaced by piston I is ejected via the left bypass line through outlet no. 6.

After shifting of piston I, lubricant flows to the left side of piston II and pushes it into its right-side home position. The displaced lubricant is ejected via outlet no. 1.

After shifting of piston II, lubricant flows to the left side of piston III and pushes it into its right-side home position. The displaced lubricant is ejected via outlet no. 2.

After shifting of piston III, lubricant flows to the right side of piston I and pushes it into its left-side home position. The displaced lubricant is ejected via outlet no. 3. The continuation of that process is evidenced in the scheme depicted.

Monitoring of progressive distributors:

As for instance due to soiling, the flow through a lubricant point line may be prevented. This will cause a piston to get blocked. By virtue of the forced control as depicted in figures 1 up to 4, the other pistons will be stopped as well. Due to this configuration, the proportioning at all outlets of the distributor can be monitored by means of a sensor at one piston only.

Mounting note:

The pistons are provided with an extremely small fitting clearance. Therefore, the pistons, after the dismantling of a distributor, must never be interchanged.

Formula for calculating the lubricant available per lubrication point:

A progressive distributor allocates the delivered lubricant to the individual lubrication points in forced order. Due to the functional process as described herein, a safe proportioning is ensured.

The lubricant q_i delivered to a lubrication point i can be calculated as follows

$$q_i = \frac{K_i}{2 * (K_1 + K_2 + K_3 \dots)} * Q$$

Q = lubricant delivered to the distributor,

K_i = distinctive number of the outlet i

- Subject to modifications -