

## Medium Pressure Filter

### Pi 3000

Nominal pressure 200/315 bar (2900/4570 psi), nominal size up to 400  
according to DIN 24550

#### 1. Features

##### High performance filters for modern hydraulic systems

- Provided for pipe installation
- Modular system
- Compact design
- Minimal pressure drop through optimal flow design
- Visual/electrical/electronic maintenance indicator
- Threaded connections
- Quality filters, easy to service
- Equipped with highly efficient glass fibre PS filter elements
- Beta rated elements according to ISO 16889
- Elements with high differential pressure stability and dirt holding capacity
- NPT- and SAE-connections on request
- Worldwide distribution



## 2. Flow rate/pressure drop curve (filter housing incl. element)

■ 190 mm<sup>2</sup>/s  
■ 33 mm<sup>2</sup>/s

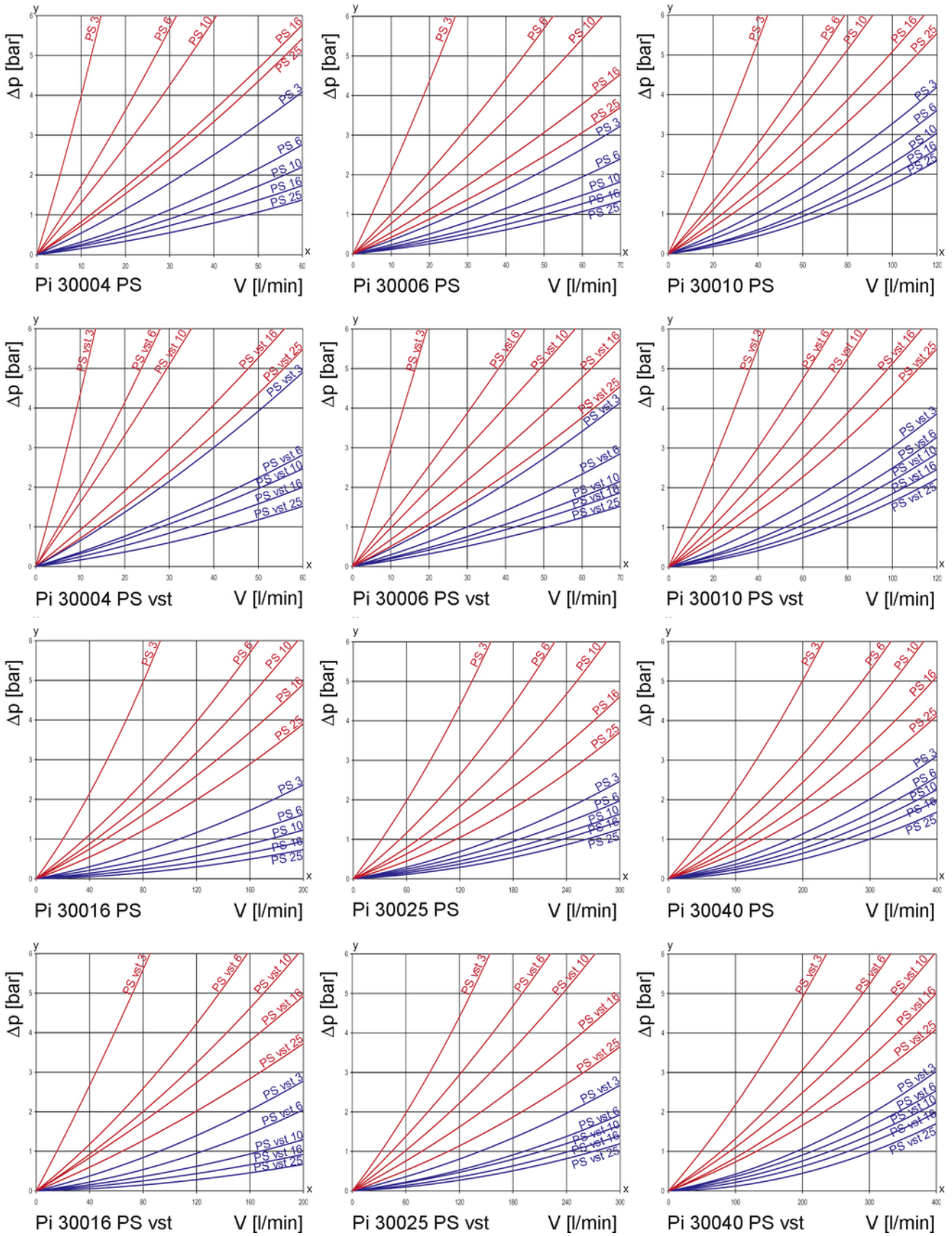

y = differential pressure  $\Delta p$  [bar]  
 x = flow rate  $V$  [l/min]

### 3. Separation grade characteristics

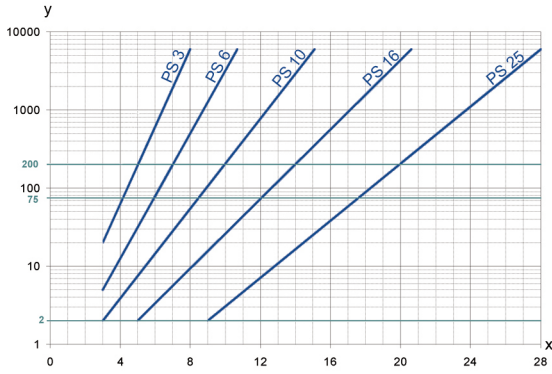

y = beta-value  
x = particle size [ $\mu\text{m}$ ]

determined by multipass tests (ISO 16889)  
calibration according to ISO 11171 (NIST)

### 5. Quality assurance

Filtration Group filters and filter elements are produced according to the following international standards:

Norm	Designation
DIN ISO 2941	Hydraulic fluid power filter elements; verification of collapse/burst resistance
DIN ISO 2942	Hydraulic fluid power filter elements; verification of fabrication integrity
DIN ISO 2943	Hydraulic fluid power filter elements; verification of material compatibility with fluids
DIN ISO 3723	Hydraulic fluid power filter elements; method for end load test
DIN ISO 3724	Hydraulic fluid power filter elements; verification of flow fatigue characteristics
ISO 3968	Hydraulic fluid power filters; evaluation of pressure drop versus flow characteristics
ISO 10771.1	Fatigue pressure testing of metal containing envelopes in hydraulic fluid applications
ISO 16889	Hydraulic fluid power filters; multipass method for evaluation filtration performance of a filter element

### 6. Symbols

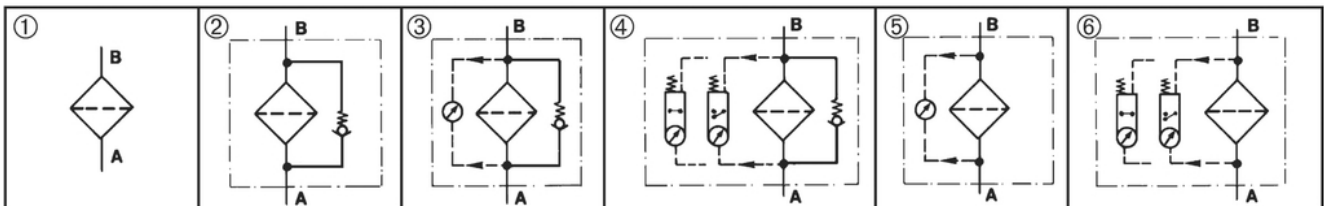

### 4. Filter performance data

tested according to ISO 16889 (multipass test)

PS elements with  
max.  $\Delta p$  20 bar

PS	3	$\beta_{5(C)} \geq 200$
PS	6	$\beta_{7(C)} \geq 200$
PS	10	$\beta_{10(C)} \geq 200$
PS	16	$\beta_{15(C)} \geq 200$
PS	25	$\beta_{20(C)} \geq 200$

values guaranteed up to  
10 bar differential pressure

PS vst elements with  
max.  $\Delta p$  210 bar

PS vst	3	$\beta_{5(C)} \geq 200$
PS vst	6	$\beta_{7(C)} \geq 200$
PS vst	10	$\beta_{10(C)} \geq 200$
PS vst	16	$\beta_{15(C)} \geq 200$
PS vst	25	$\beta_{20(C)} \geq 200$

values guaranteed up to  
20 bar differential pressure

## 7. Order numbers

Example for ordering filters:

1. Filter housing	2. Filter element
V = 100l/min and electrical maintenance indicator Type: Pi 30010-015 Order number: 78208084	PS vst 3 Type: Pi 71010 DN PS vst 3 Order number: 78227480

Nominal size NG [l/min]	Order number	Type	①	②	③	④	⑤	⑥
			with indicator cavity	with bypass valve and indicator cavity	with bypass valve and visual indicator	with bypass valve and electrical indicator	with visual indicator	with electrical indicator
40	78207896	Pi 30004-010	■					
	78207904	Pi 30004-011		■				
	78337388	Pi 30004-012			■			
	78304206	Pi 30004-013				■		
	78207938	Pi 30004-014					■	
	78207946	Pi 30004-015						■
63	78207961	Pi 30006-010	■					
	78207979	Pi 30006-011		■				
	78207987	Pi 30006-012			■			
	78304214	Pi 30006-013				■		
	78208001	Pi 30006-014					■	
	78208019	Pi 30006-015						■
100	78208035	Pi 30010-010	■					
	78208043	Pi 30010-011		■				
	78208050	Pi 30010-012			■			
	78304222	Pi 30010-013				■		
	78208076	Pi 30010-014					■	
	78208084	Pi 30010-015						■
160	78208100	Pi 30016-010	■					
	78208118	Pi 30016-011		■				
	78208126	Pi 30016-012			■			
	78259970	Pi 30016-013				■		
	78208142	Pi 30016-014					■	
	78208159	Pi 30016-015						■
250	78208167	Pi 30025-010	■					
	78208175	Pi 30025-011		■				
	78208183	Pi 30025-012			■			
	78259988	Pi 30025-013				■		
	78208209	Pi 30025-014					■	
	78208217	Pi 30025-015						■
400	78208225	Pi 30040-010	■					
	78208233	Pi 30040-011		■				
	78208241	Pi 30040-012			■			
	78259996	Pi 30040-013				■		
	78208266	Pi 30040-014					■	
	78208274	Pi 30040-015						■

When filter with non bypass configuration is selected, the collapse pressure of the element must not be exceeded.

## 7.2 Filter elements\*

Nominal size NG [l/min]	Order number	Type	Filter material	max. $\Delta p$ [bar]	Filter surface [cm <sup>2</sup> ]
40	78260929	Pi 21004 DN PS 3 NBR	PS 3	20	475
	77960859	Pi 22004 DN PS 6 NBR	PS 6		475
	77925571	Pi 23004 DN PS 10 NBR	PS 10		475
	78260937	Pi 24004 DN PS 16 NBR	PS 16		475
	78260945	Pi 25004 DN PS 25 NBR	PS 25		475
	78216079	Pi 71004 DN PS vst 3 NBR	PS vst 3	210	445
	77960156	Pi 72004 DN PS vst 6 NBR	PS vst 6		445
	77925654	Pi 73004 DN PS vst 10 NBR	PS vst 10		445
	78216087	Pi 74004 DN PS vst 16 NBR	PS vst 16		445
	78216095	Pi 75004 DN PS vst 25 NBR	PS vst 25		445
63	78260960	Pi 21006 DN PS 3 NBR	PS 3	20	835
	77960867	Pi 22006 DN PS 6 NBR	PS 6		835
	77925589	Pi 23006 DN PS 10 NBR	PS 10		835
	78260978	Pi 24006 DN PS 16 NBR	PS 16		835
	78260986	Pi 25006 DN PS 25 NBR	PS 25		835
	78216137	Pi 71006 DN PS vst 3 NBR	PS vst 3	210	780
	77960149	Pi 72006 DN PS vst 6 NBR	PS vst 6		780
	77925662	Pi 73006 DN PS vst 10 NBR	PS vst 10		780
	78216145	Pi 74006 DN PS vst 16 NBR	PS vst 16		780
	78216152	Pi 75006 DN PS vst 25 NBR	PS vst 25		780
100	78227472	Pi 21010 DN PS 3 NBR	PS 3	20	1375
	77960875	Pi 22010 DN PS 6 NBR	PS 6		1375
	77925597	Pi 23010 DN PS 10 NBR	PS 10		1375
	78261000	Pi 24010 DN PS 16 NBR	PS 16		1375
	78261018	Pi 25010 DN PS 25 NBR	PS 25		1375
	78227480	Pi 71010 DN PS vst 3 NBR	PS vst 3	210	1275
	77960131	Pi 72010 DN PS vst 6 NBR	PS vst 6		1275
	77925670	Pi 73010 DN PS vst 10 NBR	PS vst 10		1275
	78261281	Pi 74010 DN PS vst 16 NBR	PS vst 16		1275
	78216160	Pi 75010 DN PS vst 25 NBR	PS vst 25		1275

\* a wider range of element types is available on request

## 7.2 Filter elements\*

Nominal size NG [l/min]	Order number	Type	Filter material	max. $\Delta p$ [bar]	Filter surface [cm <sup>2</sup> ]
160	78261034	Pi 21016 DN PS 3 NBR	PS 3	20	2530
	77960826	Pi 22016 DN PS 6 NBR	PS 6		2530
	77925605	Pi 23016 DN PS 10 NBR	PS 10		2530
	78261042	Pi 24016 DN PS 16 NBR	PS 16		2530
	78261059	Pi 25016 DN PS 25 NBR	PS 25		2530
	77940638	Pi 71016 DN PS vst 3 NBR	PS vst 3	210	1885
	77960123	Pi 72016 DN PS vst 6 NBR	PS vst 6		1885
	77925688	Pi 73016 DN PS vst 10 NBR	PS vst 10		1885
	78269797	Pi 74016 DN PS vst 16 NBR	PS vst 16		1885
	78216178	Pi 75016 DN PS vst 25 NBR	PS vst 25		1885
250	78227514	Pi 21025 DN PS 3 NBR	PS 3	20	4020
	77960834	Pi 22025 DN PS 6 NBR	PS 6		4020
	77925613	Pi 23025 DN PS 10 NBR	PS 10		4020
	78261075	Pi 24025 DN PS 16 NBR	PS 16		4020
	78261083	Pi 25025 DN PS 25 NBR	PS 25		4020
	77940646	Pi 71025 DN PS vst 3 NBR	PS vst 3	210	3090
	77960115	Pi 72025 DN PS vst 6 NBR	PS vst 6		3090
	77925696	Pi 73025 DN PS vst 10 NBR	PS vst 10		3090
	78269813	Pi 74025 DN PS vst 16 NBR	PS vst 16		3090
	78216186	Pi 75025 DN PS vst 25 NBR	PS vst 25		3090
400	78227522	Pi 21040 DN PS 3 NBR	PS 3	20	6770
	77960842	Pi 22040 DN PS 6 NBR	PS 6		6770
	77925621	Pi 23040 DN PS 10 NBR	PS 10		6770
	78261109	Pi 24040 DN PS 16 NBR	PS 16		6770
	78261117	Pi 25040 DN PS 25 NBR	PS 25		6770
	77940653	Pi 71040 DN PS vst 3 NBR	PS vst 3	210	5240
	77960107	Pi 72040 DN PS vst 6 NBR	PS vst 6		5240
	77930829	Pi 73040 DN PS vst 10 NBR	PS vst 10		5240
	78269821	Pi 74040 DN PS vst 16 NBR	PS vst 16		5240
	78260903	Pi 75040 DN PS vst 25 NBR	PS vst 25		5240

\* a wider range of element types is available on request

## 8. Technical specifications

Design:	in-line filter
Nominal pressure:	
Pi 30004 - 30010	315 bar (4570 psi)
Pi 30016 - 30040	200 bar (2900 psi)
Test pressure:	
Pi 30004 - 30010	410 bar (5940 psi)
Pi 30016 - 30040	260 bar (3770 psi)
Temperature range:	-10 °C to +120 °C
	(other temperature ranges on request)
Bypass setting:	$\Delta p$ 7 bar $\pm$ 10 %
Filter head material:	GGG
Filter housing material:	St
Sealing material:	NBR/PTFE
Maintenance indicator setting:	$\Delta p$ 5 bar $\pm$ 10 %
Electrical data of maintenance indicator:	
Maximum voltage:	250 V AC/200 V DC
Maximum current:	1 A
Contact load:	70 W
Type of protection:	IP 65 in inserted and secured status
Contact:	normally open/closed
Cable sleeve:	M20x1.5

The switching function can be changed by turning the electric upper part by 180° (normally closed contact or normally open contact). The state on delivery is a normally closed contact. By inductivity in the direct current circuit the use of suitable protection circuit should be considered. Further maintenance indicator details and designs are available in the maintenance indicator data sheet.

We draw attention to the fact that all values indicated are average values which do not always occur in specific cases of application. Our products are continually being further developed. Values, dimensions and weights can change as a result of this. Our specialized department will be pleased to offer you advice.

We recommend you to contact us concerning applications of our filters in areas governed by the EU Directive 94/9 EC (ATEX 95). The standard version can be used for liquids based on mineral oil (corresponding to the fluids in Group 2 of Directive 97/23 EC Article 9). If you consider to use other fluids please contact us for additional support.

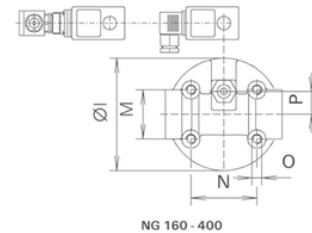
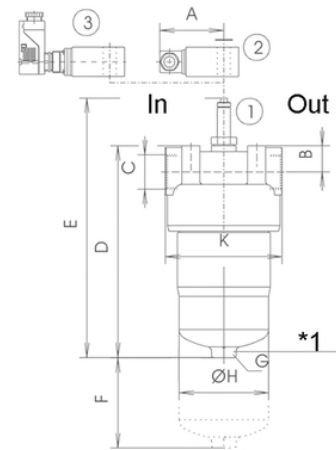

NG 160 - 400

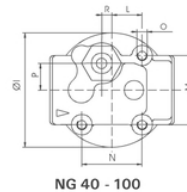

NG 40 - 100

In = inlet

Out = outlet

\*1 NG 250, 400 with drain screw G ¼ DIN 910

- Pos. 1 Visual maintenance indicator
- Pos. 2 Electrical upper section connector according DIN EN 175301-803  
Version: PiS 3092, 3105, 3115
- Pos. 3 Electrical upper section connector according DIN EN 175301-804  
Version: PiS 3102, 3122, 3132

Subject to technical alteration without prior notice.

## 9. Dimensions

All dimensions except "C" in mm.

Type	A	B	C*	D	E	F	G SW	H	I	K	L	M	N	O	P	R	Weight [kg]
Pi 30004	78	31	G½	181	238	80	27	66	90	92	23.5	54	47	M8x16	21	8	4.2
Pi 30006	78	31	G¾	241	298	80	27	66	90	92	23.5	54	47	M8x16	21	8	4.9
Pi 30010	78	31	G1	331	389	80	27	66	90	92	23.5	54	47	M8x16	21	8	5.8
Pi 30016	78	32	G1¼	267	324	110	30	109	137	142	-	60	80	M12x16	28	-	10.0
Pi 30025	78	32	G1¼	357	414	110	30	109	137	142	-	60	80	M12x16	28	-	12.0
Pi 30040	78	32	G1¼	507	564	110	30	109	137	142	-	60	80	M12x16	28	-	15.6

\* NPT- and SAE- port connections on request

## 10. Installation, operating and maintenance instructions

### 10.1 Filter installation

When installing the filter make sure that sufficient space is available to remove filter element and filter housing! Preferably the filter should be installed with the filter housing pointing downwards.

The maintenance indicator must be visible.

### 10.2 Connecting the electrical maintenance indicator

The electrical indicator is connected via a 2-pole appliance plug according to DIN EN 175301-803 with poles marked 1 and 2.

The electrical section can be inverted to change from normally open position to normally closed position or vice versa.

### 10.3 When should the filter element be replaced?

- Filters equipped with visual and electrical maintenance indicator:  
During cold starts, the indicator may give a warning signal. Press the red button of the visual indicator once again only after operating temperature has been reached. If the red button immediately pops up again and/or the electrical signal has not switched off after reaching operating temperature, the filter element must be replaced after the end of the shift.
- Filters without maintenance indicator:  
The filter element should be replaced after the trial run or flushing of the system. Afterwards follow instructions of the manufacturer.
- Please always ensure that you have Original Filtration Group spare elements in stock: Disposable elements (PS) cannot be cleaned.

### 10.4 Element replacement

- Stop system and relieve filter from pressure.
- Filter sizes 250 and 400: empty the filter housing by removing the drain plug.
- Unscrew the filter housing by turning counter-clockwise. Clean the housing using a suitable cleaning solvent.
- Remove element by pulling down carefully.
- Check o-ring and spigot for damage. Replace, if necessary.
- Make sure that the order number on the spare element corresponds to the order number of the filter name-plate. To ensure no contamination occurs during the exchange of the element first open the plastic bag and push the element over the spigot in the filter head. Now remove plastic bag.
- Lightly lubricate threads of the filter housing a little bit and screw into the filter head. Maximum tightening torque for NG 40 to 100 = 60 Nm, for NG 160 to 400 = 100 Nm.
- Check seals of vent drain plug - if necessary, please replace. Torque drain plug 30 Nm.

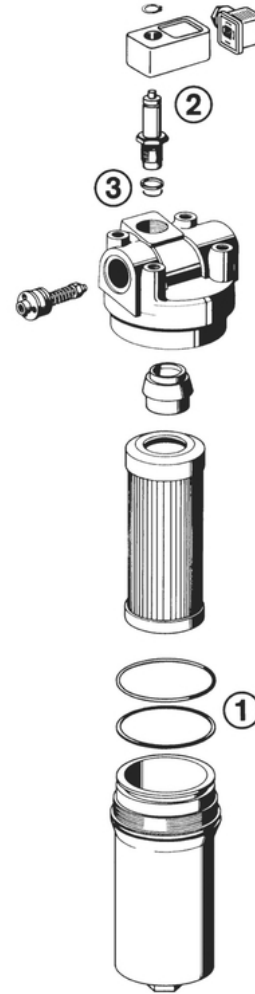

## 11. Spare parts list

Order numbers for spare parts		
Position	Type	Order number
①	Seal kit for filter	
	<b>Pi 30004 - Pi 30010</b>	
	NBR	78383747
	FPM	78383754
	EPDM	78383762
	<b>Pi 30016 - Pi 30040</b>	
	NBR	78383770
	FPM	78383788
	EPDM	78383796
②	Maintenance indicator	
	Visual PiS 3093/5	77669914
	Electrical PiS 3092/5	77669864
	Electrical upper section only	77536550
③	Seal kit for maintenance indicator	
	NBR	77760275
	FPM	77760283
	EPDM	77760291

Filtration Group GmbH  
Schleifbachweg 45  
D-74613 Öhringen  
Phone +49 7941 6466-0  
Fax +49 7941 6466-429  
sales@filtrationgroup.com  
www.filtrationgroup.com  
78396012.12/2016



## Medium Pressure Filter

### Pi 340

Nominal pressure 250/315/350 bar (3560/4480/4980 psi), nominal size up to 450  
(also available with filter elements acc. to DIN 24550)

#### 1. Features

##### High performance filters for modern hydraulic systems

- Designed for control block mounting
- Modular system
- Compact design
- Minimal pressure drop through optimal flow design
- Visual/electrical/electronic maintenance indicator
- Equipped with highly efficient glass fibre PS filter elements
- Beta rated elements according to ISO 16889 multipass test
- Elements with high differential pressure stability and dirt holding capacity
- Worldwide distribution



## 2. Flow rate/pressure drop curve (filter housing incl. element)

■ 190 mm<sup>2</sup>/s  
■ 33 mm<sup>2</sup>/s

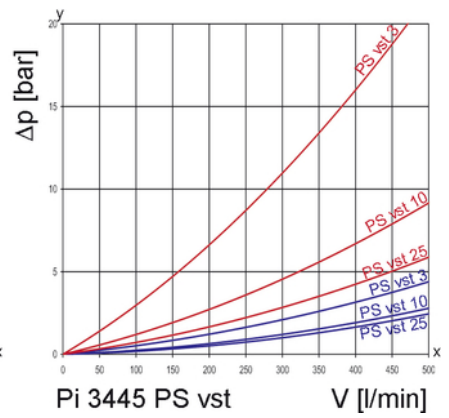
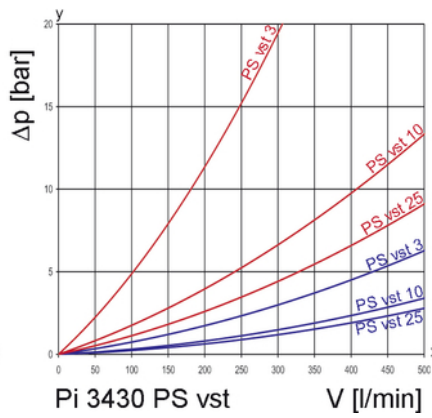
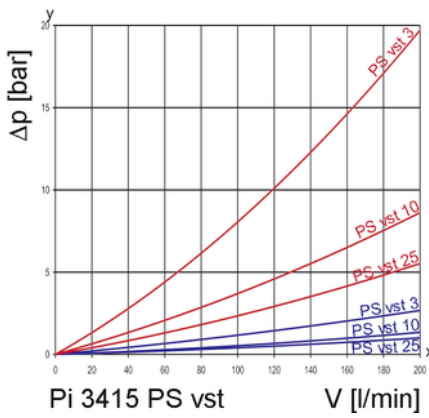
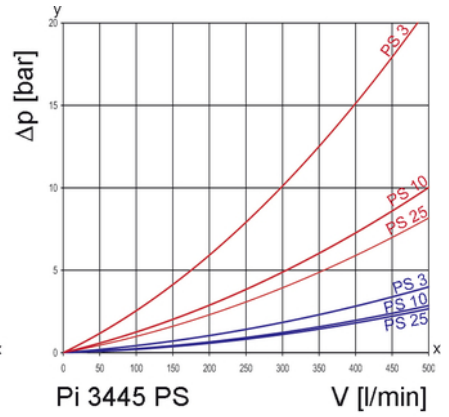
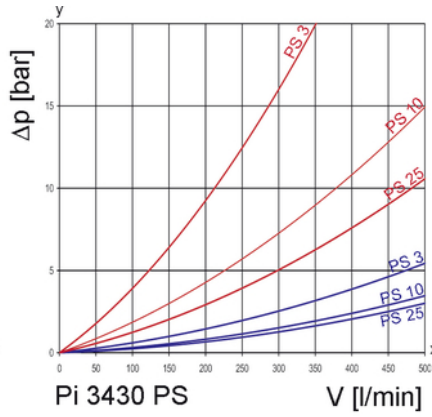
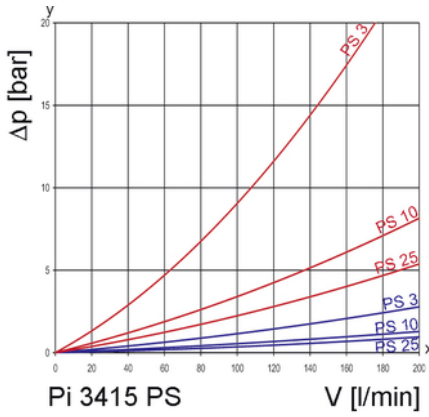
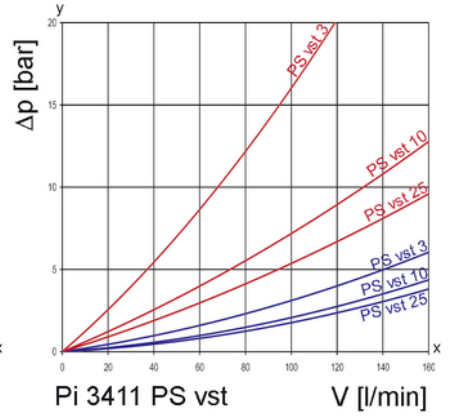
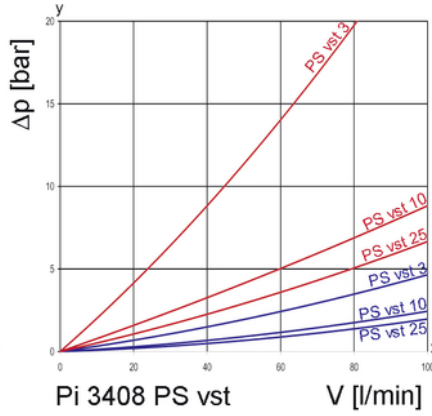
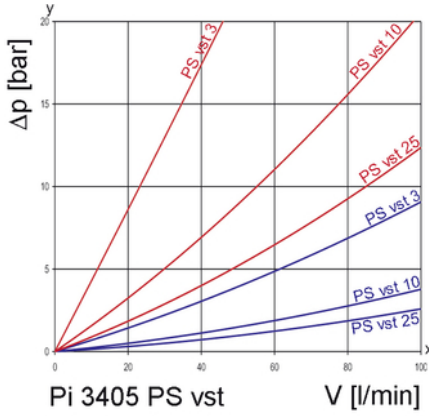
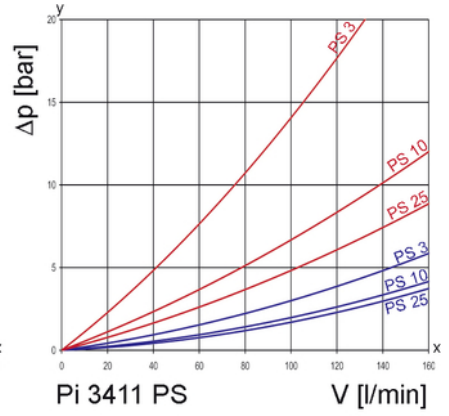
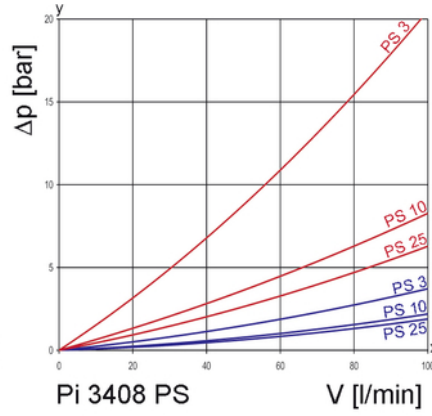
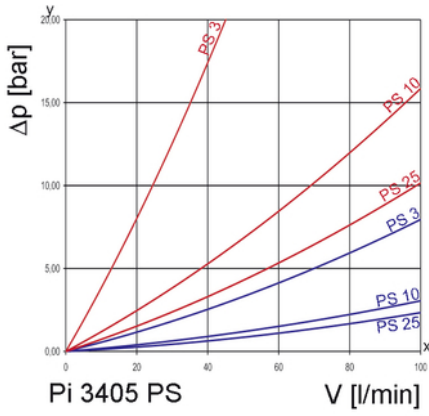

y = differential pressure  $\Delta p$  [bar]  
 x = flow rate V [l/min]

### 3. Separation grade characteristics

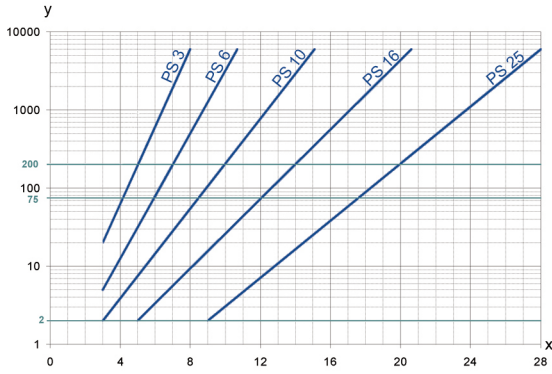

y = beta-value  
x = particle size [ $\mu\text{m}$ ]

determined by multipass tests (ISO 16889)  
calibration according to ISO 11171 (NIST)

### 5. Quality assurance

Filtration Group filters and filter elements are produced according to the following international standards:

Norm	Designation
DIN ISO 2941	Hydraulic fluid power filter elements; verification of collapse/burst resistance
DIN ISO 2942	Hydraulic fluid power filter elements; verification of fabrication integrity
DIN ISO 2943	Hydraulic fluid power filter elements; verification of material compatibility with fluids
DIN ISO 3723	Hydraulic fluid power filter elements; method for end load test
DIN ISO 3724	Hydraulic fluid power filter elements; verification flow fatigue characteristics
ISO 3968	Hydraulic fluid power filters; evaluation of pressure drop versus flow characteristics
ISO 10771.1	Fatigue pressure testing of metal containing envelopes in hydraulic fluid applications
ISO 16889	Hydraulic fluid power filters; multipass method for evaluation filtration performance of a filter element

### 6. Symbols

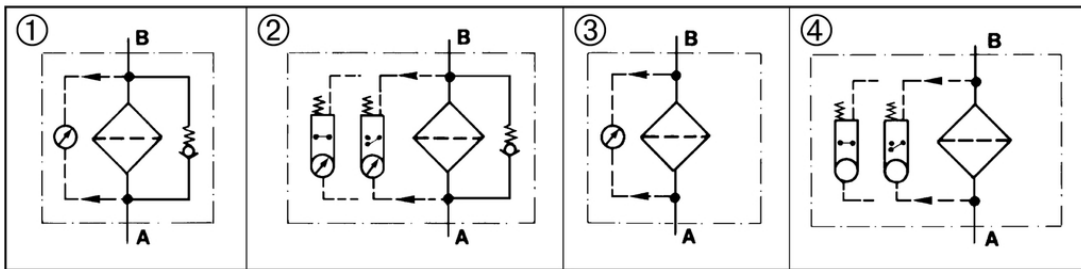

### 4. Filter performance data

tested according to ISO 16889 (multipass test)

PS elements with  
max.  $\Delta p$  20 bar

PS 3  $\beta_{5(C)} \geq 200$   
PS 6  $\beta_{7(C)} \geq 200$   
PS 10  $\beta_{10(C)} \geq 200$   
PS 25  $\beta_{20(C)} \geq 200$

values guaranteed up to  
10 bar differential pressure

PS vst elements with  
max.  $\Delta p$  210 bar

PS vst 3  $\beta_{5(C)} \geq 200$   
PS vst 6  $\beta_{7(C)} \geq 200$   
PS vst 10  $\beta_{10(C)} \geq 200$   
PS vst 25  $\beta_{20(C)} \geq 200$

values guaranteed up to  
20 bar differential pressure

## 7. Order numbers

Example for ordering filters:

1. Filtergehäuse	2. Filterelement
V = 80 l/min and electrical maintenance indicator Type: Pi 3408-015 Order number: 77874415	PS vst 3 Type: Pi 2208 PS vst 3 Order number: 77680200

7.1 Housing design						
Nominal size NG [l/min]	Order number	Type	① with bypass valve and visual indicator	② with bypass valve and electrical indicator	③ with visual indicator	④ with electrical indicator
50	77874324	Pi 3405-012				
	77874332	Pi 3405-013				
	77874340	Pi 3405-014				
	77874357	Pi 3405-015				
80	77874381	Pi 3408-012				
	78274136	Pi 3408-013				
	77874407	Pi 3408-014				
	77874415	Pi 3408-015				
110	77874449	Pi 3411-012				
	77874456	Pi 3411-013				
	77874464	Pi 3411-014				
	77874472	Pi 3411-015				
150	77921919	Pi 3415-012				
	77921927	Pi 3415-013				
	77921935	Pi 3415-014				
	77921943	Pi 3415-015				
300	77921968	Pi 3430-012				
	77921976	Pi 3430-013				
	77921984	Pi 3430-014				
	77921992	Pi 3430-015				
450	77922008	Pi 3445-012				
	77922016	Pi 3445-013				
	77922024	Pi 3445-014				
	77922032	Pi 3445-015				

When filter with non bypass configuration is selected, the collapse pressure of the element must not be exceeded.

**7.2 Filter elements (a wider range of element types is available on request)**

Nominal size NG [l/min]	Order number	Type	Filter material	max. Δp [bar]	Filter surface [cm <sup>2</sup> ]
50	77680135	Pi 2105 PS 3	PS 3	20	590
	77943509	Pi 5105 PS 6	PS 6		590
	77680325	Pi 3105 PS 10	PS 10		590
	77680440	Pi 4105 PS 25	PS 25		590
	77680192	Pi 2205 PS vst 3	PS vst 3	210	425
	77943533	Pi 5205 PS vst 6	PS vst 6		425
	77680382	Pi 3205 PS vst 10	PS vst 10		425
	77680507	Pi 4205 PS vst 25	PS vst 25		425
80	77680143	Pi 2108 PS 3	PS 3	20	1150
	77943517	Pi 5108 PS 6	PS 6		1150
	77680341	Pi 3108 PS 10	PS 10		1150
	77680457	Pi 4108 PS 25	PS 25		1150
	77680200	Pi 2208 PS vst 3	PS vst 3	210	850
	77943541	Pi 5208 PS vst 6	PS vst 6		850
	77681190	Pi 3208 PS vst 10	PS vst 10		850
	77680515	Pi 4208 PS vst 25	PS vst 25		850
110	77680150	Pi 2111 PS 3	PS 3	20	1700
	77943525	Pi 5111 PS 6	PS 6		1700
	77680333	Pi 3111 PS 10	PS 10		1700
	77680465	Pi 4111 PS 25	PS 25		1700
	77680218	Pi 2211 PS vst 3	PS vst 3	210	1275
	77943558	Pi 5211 PS vst 6	PS vst 6		1275
	77680390	Pi 3211 PS vst 10	PS vst 10		1275
	77680523	Pi 4211 PS vst 25	PS vst 25		1275
150	77680168	Pi 2115 PS 3	PS 3	20	2425
	77955099	Pi 5115 PS 6	PS 6		2425
	77680358	Pi 3115 PS 10	PS 10		2425
	77680473	Pi 4115 PS 25	PS 25		2425
	77680226	Pi 2215 PS vst 3	PS vst 3	210	2010
	77955123	Pi 5215 PS vst 6	PS vst 6		2010
	77680408	Pi 3215 PS vst 10	PS vst 10		2010
	77680531	Pi 4215 PS vst 25	PS vst 25		2010
300	77680176	Pi 2130 PS 3	PS 3	20	4620
	77955107	Pi 5130 PS 6	PS 6		4620
	77680366	Pi 3130 PS 10	PS 10		4620
	77680481	Pi 4130 PS 25	PS 25		4620
	77680234	Pi 2230 PS vst 3	PS vst 3	210	3800
	77955131	Pi 5230 PS vst 6	PS vst 6		3800
	77680416	Pi 3230 PS vst 10	PS vst 10		3800
	77680549	Pi 4230 PS vst 25	PS vst 25		3800
450	77680184	Pi 2145 PS 3	PS 3	20	6865
	77955115	Pi 5145 PS 6	PS 6		6865
	77680374	Pi 3145 PS 10	PS 10		6865
	77680499	Pi 4145 PS 25	PS 25		6865
	77680242	Pi 2245 PS vst 3	PS vst 3	210	5600
	77955149	Pi 5245 PS vst 6	PS vst 6		5600
	77680424	Pi 3245 PS vst 10	PS vst 10		5600
	77680556	Pi 4245 PS vst 25	PS vst 25		5600

## 8. Technical specifications

Design:	flange filter
Nominal pressure: Pi 3405-3411	350 bar (4980 psi)
Pi 3415-3445 without bypass	315 bar (4480 psi)
Pi 3415-3445 with bypass	250 bar (3560 psi)
Test pressure: Pi 3405-3411	450 bar (6400 psi)
Pi 3415-3445 without bypass	410 bar (5830 psi)
Pi 3415-3445 with bypass	325 bar (4620 psi)
Temperature range:	-10 °C to +120 °C (other temperature ranges on request)
Bypass setting:	$\Delta p$ 7 bar $\pm$ 10 %
Filter head material:	GGG
Filter housing material:	St
Sealing material:	NBR/PTFE
Maintenance indicator setting:	$\Delta p$ 5 bar $\pm$ 10 %
Electrical data of maintenance indicator:	
Maximum voltage:	250 V AC/200 V DC
Maximum current:	1 A
Contact load:	70 W
Type of protection:	IP 65 in inserted and secured status
Contact:	normally open/closed
Cable sleeve:	M20x1.5

The switching function can be changed by turning the electric upper part by 180° (normally closed contact or normally open contact). The state on delivery is a normally closed contact. By the inductivity in the direct current circuit the use of suitable protection circuit should be considered. Further maintenance indicator details and designs are available in the maintenance data sheet.

We draw attention to the fact that all values indicated are average values and do not always occur in specific cases of application. Our products are continually being further developed. Values, dimensions and weights can change as a result of this. Our specialized department will be pleased to offer you advice.

We recommend you to contact us concerning applications of our filters in areas governed by the EU Directive 94/9 EC (ATEX 95). The standard version can be used for liquids based on mineral oil (corresponding to the fluids in Group 2 of Directive 97/23 EC Article 9). If you consider to use other fluids please contact us for additional support.

Subject to technical alteration without prior notice.

## 9. Dimensions

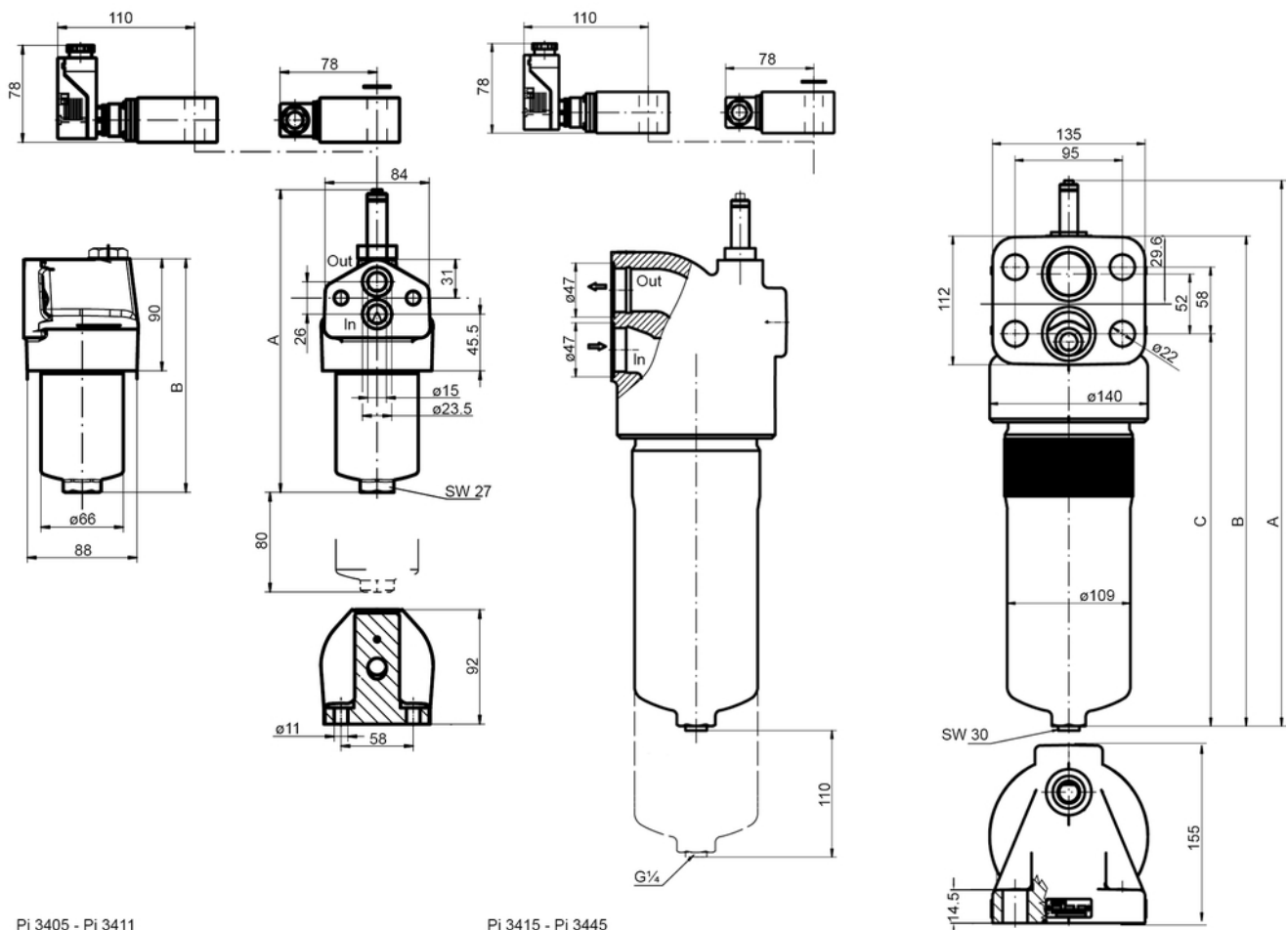

Pi 3405 - Pi 3411

Pi 3415 - Pi 3445

In = inlet  
Out = outlet

Attachment screws (property class 12.9) are not included in the delivery.

All dimensions in mm.

Type	A	B	C	Weight [kg]
Pi 3405	241	188	-	3.7
Pi 3408	320	265	-	4.7
Pi 3411	395	342	-	5.5
Pi 3415	360	305	227	14.4
Pi 3430	474	419	341	17.3
Pi 3445	590	535	457	19.4

## 10. Installation, operating and maintenance instructions

### 10.1 Filter installation

When installing the filter make sure that sufficient space is available to remove filter element and filter housing. Preferably the filter should be installed with the filter housing pointing downwards. The maintenance indicator must be visible.

### 10.2 Connecting the electrical maintenance indicator

The electrical connection is connected via a 2-pole appliance plug according to DIN EN 175301-803 with poles marked 1 and 2. The electrical section can be inverted to change from normally open position to normally closed position or vice versa.

### 10.3 When should the filter element be replaced?

- Filters equipped with visual and electrical maintenance indicator:  
During cold starts, the indicator may give a warning signal. Press the red button of the visual indicator once again only after operating temperature has been reached. If the red button immediately pops up again and/or the electrical signal has not switched off after reaching operating temperature, the filter element must be replaced after the end of the shift.
- Filters without maintenance indicator:  
The filter element should be replaced after the trial run or flushing of the system. Afterwards follow instructions of the manufacturer.
- Please always ensure that you have original Filtration Group spare elements in stock: Disposable elements (PS) cannot be cleaned.

### 10.4 Element replacement

- Stop system and relieve filter from pressure.
- Filter sizes 300 and 450: empty the filter housing by removing the drain plug.
- Unscrew the filter housing by turning counter-clockwise. Clean the housing using a suitable cleaning solvent.
- Remove element by pulling down carefully.
- Check o-ring, spigot and o-ring in the element locator for damage. Replace, if necessary.
- Make sure that the order number on the spare element corresponds to the order number of the filter name-plate.  
To ensure no contamination occurs during the exchange of the element first open the plastic bag and push the element over the spigot in the filter head. Now remove plastic bag.
- Lightly lubricate the threads of the filter housing a little bit and screw into the filter head. Maximum tightening torque for NG 50 to 110 = 60 Nm, for NG 150 to 450 = 100 Nm.
- Check seals of vent drain plug - if necessary, please replace. Torque drain plug 30 Nm.

## 11. Spare parts list

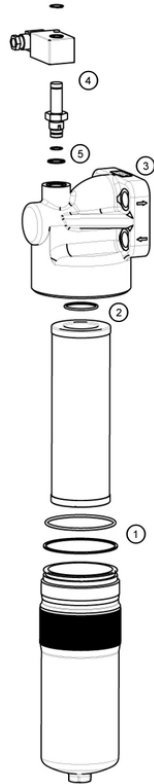

Order numbers for spare parts		
Position	Type	Order number
① bis ③	Seal kit for filter	
	<b>Pi 3405 - Pi 3411</b>	
	NBR	77850381
	FPM	77850399
	EPDM	77850407
	<b>Pi 3415 - Pi 3445</b>	
	NBR	77936206
	FPM	77936214
	EPDM	77936222
④	Maintenance indicator	
	Visual 5 bar PiS 3093/5	77669914
	Electrical 5 bar PiS 3092/5	77669864
	Electrical upper section only	77536550
⑤	Seal kit for maintenance indicator	
	NBR	77760275
	FPM	77760283
	EPDM	77760291

Filtration Group GmbH  
 Schleifbachweg 45  
 D-74613 Öhringen  
 Phone +49 7941 6466-0  
 Fax +49 7941 6466-429  
 sales@filtrationgroup.com  
 www.filtrationgroup.com  
 78356750.11/2016



## Medium Pressure Filter

### Pi 360

Nominal pressure 210/315 bar (2990/4480 psi), nominal size up to 450

#### 1. Features

##### High performance filters for modern hydraulic systems

- Provided for pipe installation
- Modular system
- Compact design
- Minimal pressure drop through optimal flow design
- Visual/electrical/electronic maintenance control
- Threaded connections
- Change over valve on upstream side
- Ergonomic switch-over handle with safety lock and pressure compensation
- User-optimized one-hand-operation
- Equipped with highly efficient glass fibre PS filter elements
- Beta rated elements according to ISO 16889 multipass test
- Elements with high differential pressure stability and dirt holding capacity
- NPT- and SAE-connections on request
- Worldwide distribution



## 2. Flow rate/pressure drop curve (filter housing incl. element)

■ 190 mm<sup>2</sup>/s  
■ 33 mm<sup>2</sup>/s

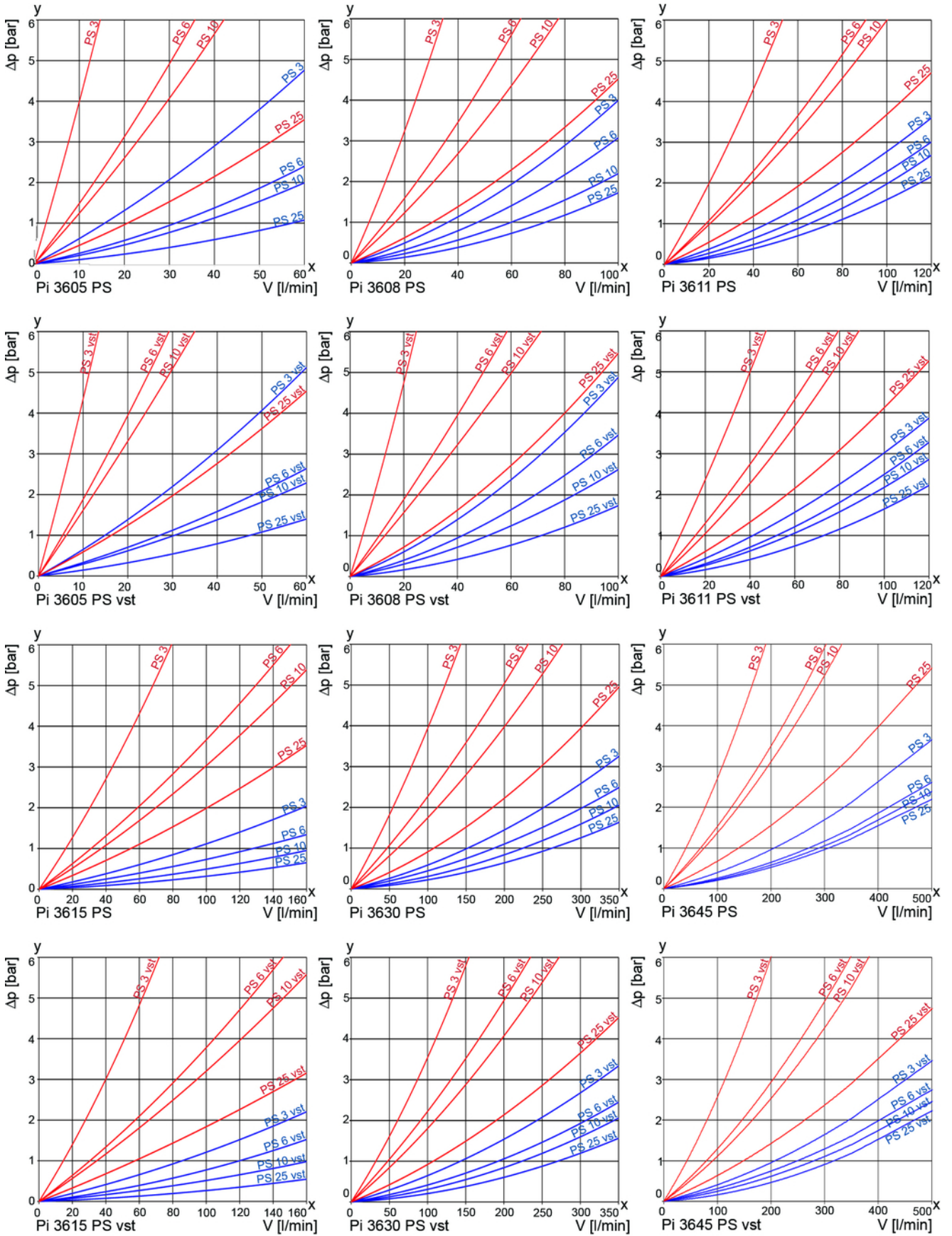

y = differential pressure  $\Delta p$  [bar]

x = flow rate  $V$  [l/min]

### 3. Separation grade characteristics

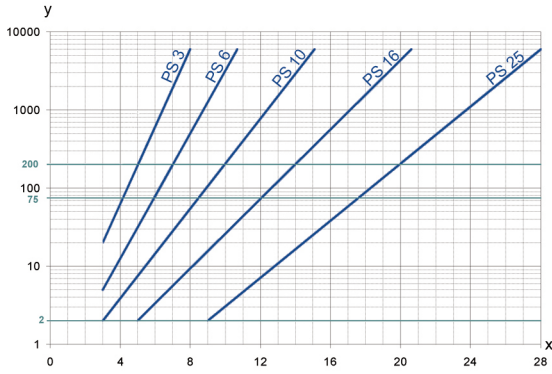

y = beta-value  
x = particle size [µm]

determined by multipass tests (ISO 16889)  
calibration according to ISO 1171 (NIST)

### 5. Quality assurance

Filtration Group filters and filter elements are produced according to the following international standards:

Norm	Designation
DIN ISO 2941	Hydraulic fluid power filter elements; verification of collapse/burst resistance
DIN ISO 2942	Hydraulic fluid power filter elements; verification of fabrication integrity
DIN ISO 2943	Hydraulic fluid power filter elements; verification of material compatibility with fluids
DIN ISO 3723	Hydraulic fluid power filter elements; method for end load test
DIN ISO 3724	Hydraulic fluid power filter elements; verification of flow fatigue characteristics
ISO 3968	Hydraulic fluid power filters; evaluation of pressure drop versus flow characteristics
ISO 10771.1	Fatigue pressure testing of metal containing envelopes in hydraulic fluid applications
ISO 16889	Hydraulic fluid power filters; multipass method for evaluation filtration performance of a filter element

### 6. Symbols

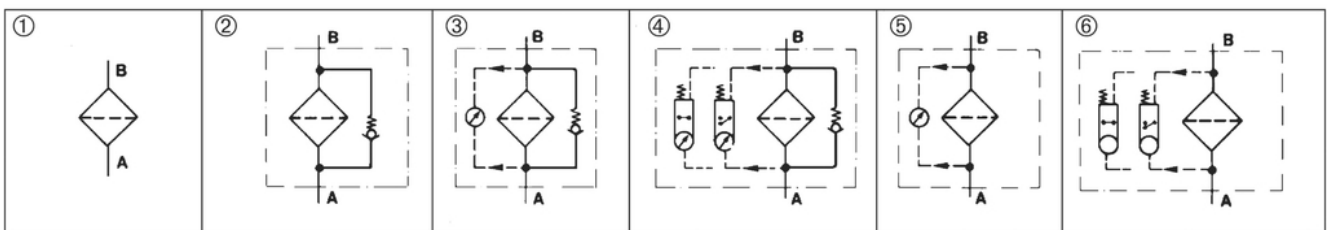

### 4. Filter performance data

tested according to ISO 16889 (multipass test)

PS elements with  
max. Δ p 20 bar

PS 3 β<sub>5(C)</sub> ≥ 200  
PS 6 β<sub>7(C)</sub> ≥ 200  
PS 10 β<sub>10(C)</sub> ≥ 200  
PS 25 β<sub>20(C)</sub> ≥ 200

PS vst elements with  
max. Δ p 210 bar

PS vst 3 β<sub>5(C)</sub> ≥ 200  
PS vst 6 β<sub>7(C)</sub> ≥ 200  
PS vst 10 β<sub>10(C)</sub> ≥ 200  
PS vst 25 β<sub>20(C)</sub> ≥ 200

values guaranteed up to  
10 bar differential pressure

values guaranteed up to  
20 bar differential pressure

## 7. Order numbers

Example for ordering filters:

1. Filter housing	2. Filter element
V = 80 l/min and electrical maintenance indicator Type: Pi 3608-15 Order number: 77666282	PS vst 3 Type: Pi 2208 PS vst 3 Order number: 77680200

7.1 Housing design								
Nominal size NG [l/min]	Order number	Type	① no options	② with bypass and indicator cavity	③ with bypass and visual indicator	④ with bypass and electrical indicator	⑤ with visual indicator	⑥ with electrical indicator
50	77655996	Pi 3605-060						
	77666217	Pi 3605-011						
	77666225	Pi 3605-012						
	77656044	Pi 3605-013						
	77666233	Pi 3605-014						
	77666241	Pi 3605-015						
80	77656002	Pi 3608-060						
	77666258	Pi 3608-011						
	77666266	Pi 3608-012						
	77656036	Pi 3608-013						
	77666274	Pi 3608-014						
	77666282	Pi 3608-015						
110	77656010	Pi 3611-060						
	77666290	Pi 3611-011						
	77666308	Pi 3611-012						
	77656028	Pi 3611-013						
	77731821	Pi 3611-014						
	77666316	Pi 3611-015						
150	77647845	Pi 3615-060						
	77731854	Pi 3615-011						
	77666324	Pi 3615-012						
	77655988	Pi 3615-013						
	77731862	Pi 3615-014						
	77731847	Pi 3615-015						
300	77655970	Pi 3630-060						
	77731896	Pi 3630-011						
	77666332	Pi 3630-012						
	77647837	Pi 3630-013						
	77731904	Pi 3630-014						
	77731888	Pi 3630-015						
450	70328126	Pi 3645-060						
	79343153	Pi 3645-011						
	79350810	Pi 3645-012						
	77883648	Pi 3645-013						
	79343161	Pi 3645-014						
	78299307	Pi 3645-015						

When filter with non bypass configuration is selected, the collapse pressure of the element must not be exceeded.

**7.2 Filter elements (a wider range of element types is available on request)**

Nominal size NG [l/min]	Order number	Type	Filter material	max. $\Delta p$ [bar]	Filter surface [cm <sup>2</sup> ]
50	77680135	Pi 2105 PS 3	PS 3	20	590
	77943509	Pi 5105 PS 6	PS 6		590
	77680325	Pi 3105 PS 10	PS 10		590
	77680440	Pi 4105 PS 25	PS 25		590
	77680192	Pi 2205 PS vst 3	PS vst 3	210	425
	77943533	Pi 5205 PS vst 6	PS vst 6		425
	77680382	Pi 3205 PS vst 10	PS vst 10		425
	77680507	Pi 4205 PS vst 25	PS vst 25		425
80	77680143	Pi 2108 PS 3	PS 3	20	1150
	77943517	Pi 5108 PS 6	PS 6		1150
	77680341	Pi 3108 PS 10	PS 10		1150
	77680457	Pi 4108 PS 25	PS 25		1150
	77680200	Pi 2208 PS vst 3	PS vst 3	210	850
	77943541	Pi 5208 PS vst 6	PS vst 6		850
	77681190	Pi 3208 PS vst 10	PS vst 10		850
	77680515	Pi 4208 PS vst 25	PS vst 25		850
110	77680150	Pi 2111 PS 3	PS 3	20	1700
	77943525	Pi 5111 PS 6	PS 6		1700
	77680333	Pi 3111 PS 10	PS 10		1700
	77680465	Pi 4111 PS 25	PS 25		1700
	77680218	Pi 2211 PS vst 3	PS vst 3	210	1275
	77943558	Pi 5211 PS vst 6	PS vst 6		1275
	77680390	Pi 3211 PS vst 10	PS vst 10		1275
	77680523	Pi 4211 PS vst 25	PS vst 25		1275
150	77680168	Pi 2115 PS 3	PS 3	20	2425
	77955099	Pi 5115 PS 6	PS 6		2425
	77680358	Pi 3115 PS 10	PS 10		2425
	77680473	Pi 4115 PS 25	PS 25		2425
	77680226	Pi 2215 PS vst 3	PS vst 3	210	2010
	77955123	Pi 5215 PS vst 6	PS vst 6		2010
	77680408	Pi 3215 PS vst 10	PS vst 10		2010
	77680531	Pi 4215 PS vst 25	PS vst 25		2010
300	77680176	Pi 2130 PS 3	PS 3	20	4620
	77955107	Pi 5130 PS 6	PS 6		4620
	77680366	Pi 3130 PS 10	PS 10		4620
	77680481	Pi 4130 PS 25	PS 25		4620
	77680234	Pi 2230 PS vst 3	PS vst 3	210	3800
	77955131	Pi 5230 PS vst 6	PS vst 6		3800
	77680416	Pi 3230 PS vst 10	PS vst 10		3800
	77680549	Pi 4230 PS vst 25	PS vst 25		3800
450	77680184	Pi 2145 PS 3	PS 3	20	6865
	77955115	Pi 5145 PS 6	PS 6		6865
	77680374	Pi 3145 PS 10	PS 10		6865
	77680499	Pi 4145 PS 25	PS 25		6865
	77680242	Pi 2245 PS vst 3	PS vst 3	210	5600
	77955149	Pi 5245 PS vst 6	PS vst 6		5600
	77680424	Pi 3245 PS vst 10	PS vst 10		5600
	77680556	Pi 4245 PS vst 25	PS vst 25		5600

## 8. Technical specifications

Design:	line mounting filter
Nominal pressure: Pi 3615-3645	210 bar (2990 psi)
Pi 3605, 3608, 3611	315 bar (4480 psi)
Test pressure: Pi 3615-3645	275 bar (3910 psi)
Pi 3605, 3608, 3611	410 bar (5830 psi)
Temperature range:	-10 °C to +120 °C
	(other temperature ranges on request)
Bypass setting:	$\Delta p$ 7 bar $\pm$ 10 %
Filter head material:	GGG
Filter housing material:	St
Sealing material:	NBR/PTFE
Maintenance indicator setting:	$\Delta p$ 5 bar $\pm$ 10 %
Electrical data of maintenance indicator:	
Max. voltage:	250 V AC/200 V DC
Max. current:	1 A
Contact load:	70 W
Type of protection:	IP 65 in inserted and secured status
Contact:	normally open/closed
Cable sleeve:	M20x1.5

The switching function can be changed by turning the electric upper part by 180° (normally closed contact or normally open contact). The state on delivery is a normally closed contact. By inductivity in the direct current circuit the use of suitable protection circuit should be considered. Further maintenance indicator details and designs are available in the maintenance indicator data sheet.

We draw attention to the fact that all values indicated are average values which do not always occur in specific cases of application. Our products are continually being further developed. Values, dimensions and weights can change as a result of this. Our specialized department will be pleased to offer you advice.

We recommend to contact us concerning applications of filters in areas governed by the EU Directive 94/9 EC (ATEX 95). The standard version can be used for liquids based on mineral oil (corresponding to the fluids in Group 2 of Directive 97/23 EC Article 9). If you consider to use other fluids please contact us for additional support.

Subject to technical alteration without prior notice.

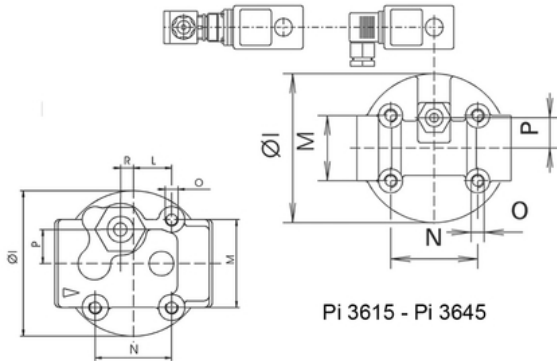
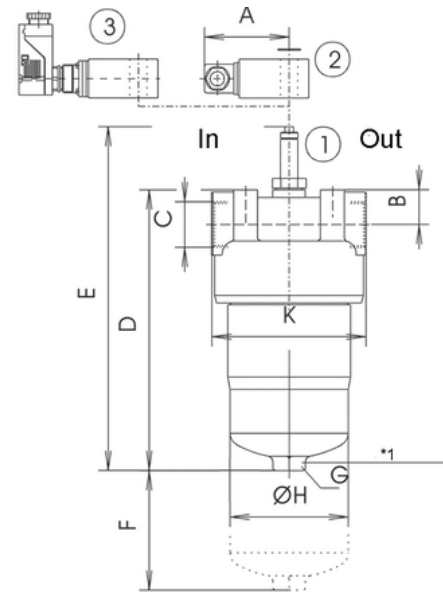

Pi 3605 - Pi 3611

Pi 3615 - Pi 3645

- In = inlet
- Out = outlet
- Pos 1 - Visual maintenance indicator
- Pos 2 - Electrical upper section connector according DIN EN 175301-803
- Executions: Pis 3092, 3105, 3115
- Pos 3 - Electrical upper section connector according DIN EN 175201-804
- Executions: Pis 3102, 3122, 3110, 3132

\*1 NG 300 and NG 450 with drain screw G $\frac{1}{4}$

## 9. Dimensions

All dimensions except "C" in mm.

Type	A	B	C*	D	E	F	G SW	H	I	K	L	M	N	O	P	R	Weight [kg]
Pi 3605	78	31	G $\frac{1}{2}$	189	247	80	27	66	90	92	23.5	54	47	M8x16	21	8	4.1
Pi 3608	78	31	G $\frac{3}{4}$	267	325	80	27	66	90	92	23.5	54	47	M8x16	21	8	5.0
Pi 3611	78	31	G $\frac{1}{2}$	343	401	80	27	66	90	92	23.5	54	47	M8x16	21	8	5.9
Pi 3615	78	32	G1 $\frac{1}{4}$	257	312	110	30	109	137	142	-	60	80	M12x16	30	-	9.8
Pi 3630	78	32	G1 $\frac{1}{4}$	371	426	110	30	109	137	142	-	60	80	M12x16	30	-	12.5
Pi 3645	78	32	G1 $\frac{1}{4}$	487	542	110	30	109	137	142	-	60	80	M12x16	30	-	14.0

\* NPT- and SAE- port connections on request

## 10. Installation, operating and maintenance instructions

### 10.1 Filter installation

When installing the filter make sure that sufficient space is available to remove filter element and filter housing. Preferably the filter should be installed with the filter housing pointing downwards.

The maintenance indicator must be visible.

### 10.2 Connecting the electrical maintenance indicator

The electrical indicator is connected via a 2-pole appliance plug according to DIN EN 175301-803 with poles marked 1 and 2. The electrical section can be inverted to change from normally open to normally closed position or vice versa.

### 10.3 When should the filter be replaced?

- Filters equipped with visual and electrical maintenance indicator:  
During cold starts, the indicator may give a warning signal. Press the red button of the visual indicator once again only after operating temperature has been reached. If the red button immediately pops up again and/or the electrical signal has not switched off after reaching operating temperature. The filter element must be replaced after the end of the shift.
- Filters without maintenance indicator: The filter element should be replaced after trial run or flushing of the system. Afterwards follow instructions of the manufacturer.
- Please always ensure that you have original Filtration Group spare elements in stock: Disposable elements (PS) cannot be cleaned.

### 10.4 Element replacement

- Stop system and relieve filter from pressure.
- Filter sizes 300 and 450: empty the filter housing by removing the drain plug.
- Unscrew the filter housing by turning counter-clockwise. Clean the housing using a suitable cleaning solvent.
- Remove element by pulling down carefully.
- Check o-ring, spigot and o-ring in the element locator for damage. Replace, if necessary.
- Make sure that the order number on the spare element corresponds to the order number of the filter name-plate. To ensure no contamination occurs during the exchange of the element first open the plastic bag and push the element over the spigot in the filter head. Now remove plastic bag.
- Lightly lubricate the threads of the filter housing a little bit and screw into the filter head. Maximum tightening torque for NG 50 to 110 = 60 Nm, for NG 150 to 450 = 100 Nm.
- Check seals of vent drain plug - if necessary, please replace.  
Torque drain plug 30 Nm.

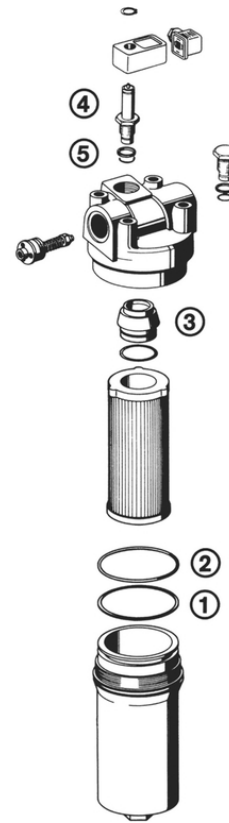

## 11. Spare parts list

Order numbers for spare parts		
Position	Type	Order number
① - ③	Seal kit	
	<b>Pi 3605 - Pi 3611</b>	
	NBR	77637150
	FPM	77637168
	EPDM	77637176
	<b>Pi 3615 - Pi 3645</b>	
	NBR	77637184
	FPM	77637192
	EPDM	77637200
④	Maintenance indicator	
	Visual PiS 3093/5	77669914
	Visual/electrical PiS 3092/5	77669864
	Electrical upper section only	77536550
⑤	Seal kit for maintenance indicator	
	NBR	77760275
	FPM	77760283
	EPDM	77760291

Filtration Group GmbH  
Schleifbachweg 45  
D-74613 Öhringen  
Phone +49 7941 6466-0  
Fax +49 7941 6466-429  
sales@filtrationgroup.com  
www.filtrationgroup.com  
78356834.11/2016